

BOMBO



BOMBO

Dimensioni due ante/ Two doors sizes / Maße 2-türig
700/800/900x650x150mm

Dimensioni tre ante/ Three doors sizes / Maße 3-türig
1050/1150x650x150mm

Zona dedicata/ Zone / Zone

2 - 3

Consumo Energetico/ Energy Class / Energieklasse

A++

Classe di protezione/ Protection Class / Schutzklasse

IP44

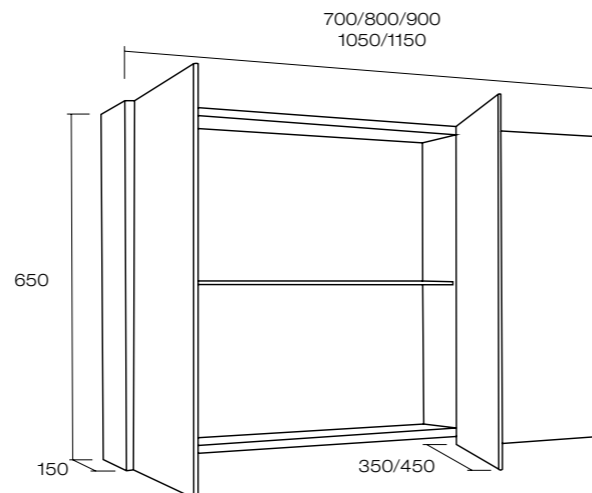

Accessori/ accessories / accessoires / Zubehör



Struttura: MFC grigio o bianco mm.16 classe E1 W100

Fianchi: Specchio mm.3 Mirox 3G, incollaggio con polimero sigillante MS

Anta: Specchio+Specchio (mm.3+3) Specchio Mirox 3G, incollaggio con polimero sigillante MS

Sicurezza Specchio: Pellicola di sicurezza interna antischeggia e antisfondamento

Cerniere: 125° con frenata integrata, innesto rapido e regolazione tridirezionale

Attaccaglie: a pressione in acciaio regolazione bidirezionale con cover portata 130 kg/ coppia

Ripiano: in vetro mm.6 con ferramenta in acciaio inox autobloccante

Illuminazione:

Alimentazione:



Frame: gray or white MFC mm.16 E1 W100

Hips: Mirror mm.3 Mirox 3G, gluing with MS polymer sealant

Door: Mirror + Mirror (mm.3+3) mirror Mirox 3G, bonding with MS polymer sealant

Safety Mirror: Rear Safety film anti-splinter and anti-breaching

Hinges: 125° with integrated braking, quick coupling and three-way adjustment

Hangers: pressured steel hangers with bidirectional adjustment and cover, load bearing capacity 130kg/pair

Shelf: in 6 mm glass with self-locking stainless steel hardware

Lighting:

Power Supply:



Structure: MFC gris ou blanc mm.16 classe E1 W100

Cotés: MFC mm.3 structurel gris ou blanc

Porte: Miroir+ Miroir (mm.3+3) Mirox 3G, collage par polymère MS

Sécurité Miroir: Pellicule interne de sécurité anti-éclats et anti-brise

Charnières: 125° avec Soft-Close intégré et réglage en trois directions

Fixation: à pression, en acier avec réglage bidirectionnel, portée 130 kg/ paire

Etagère: en verre mm.6 ferrure de fixation autobloquantes en acier inoxydable

Eclairage:

Alimentation:



Korpus: grau oder weiß in MFC 16 mm Kategorie E1 W100

Seiten: Spiegel 3 mm Mirox 3G, feuchtigkeitsresistente Verleimung mit MS-Polymerkleber

Türe: Spiegel + Spiegel (3 +3 mm) Mirox Spiegel 3G, Verleimung durch abdichtenden MS-Polymerkleber

Sicherheitschutz: interne Sicherheitsfolie zur Verhinderung von Splitterung und Bruch

Scharniere: 125° mit integrierter Dämpfung, Schnellmontage und dreidimensionaler Einstellung

Aufhängebeschläge: Druckguss, aus Stahl zur bidirektionalen Regulierung mit Abdeckkappen, Belastbarkeit 130 kg/ pro Paar

Einlegeboden: aus Glas 6 mm mit selbstsperrenden rostfreien Stahlschrauben

Beleuchtungssystem: Stromversorgung:

BOMBO CON ILLUMINAZIONE

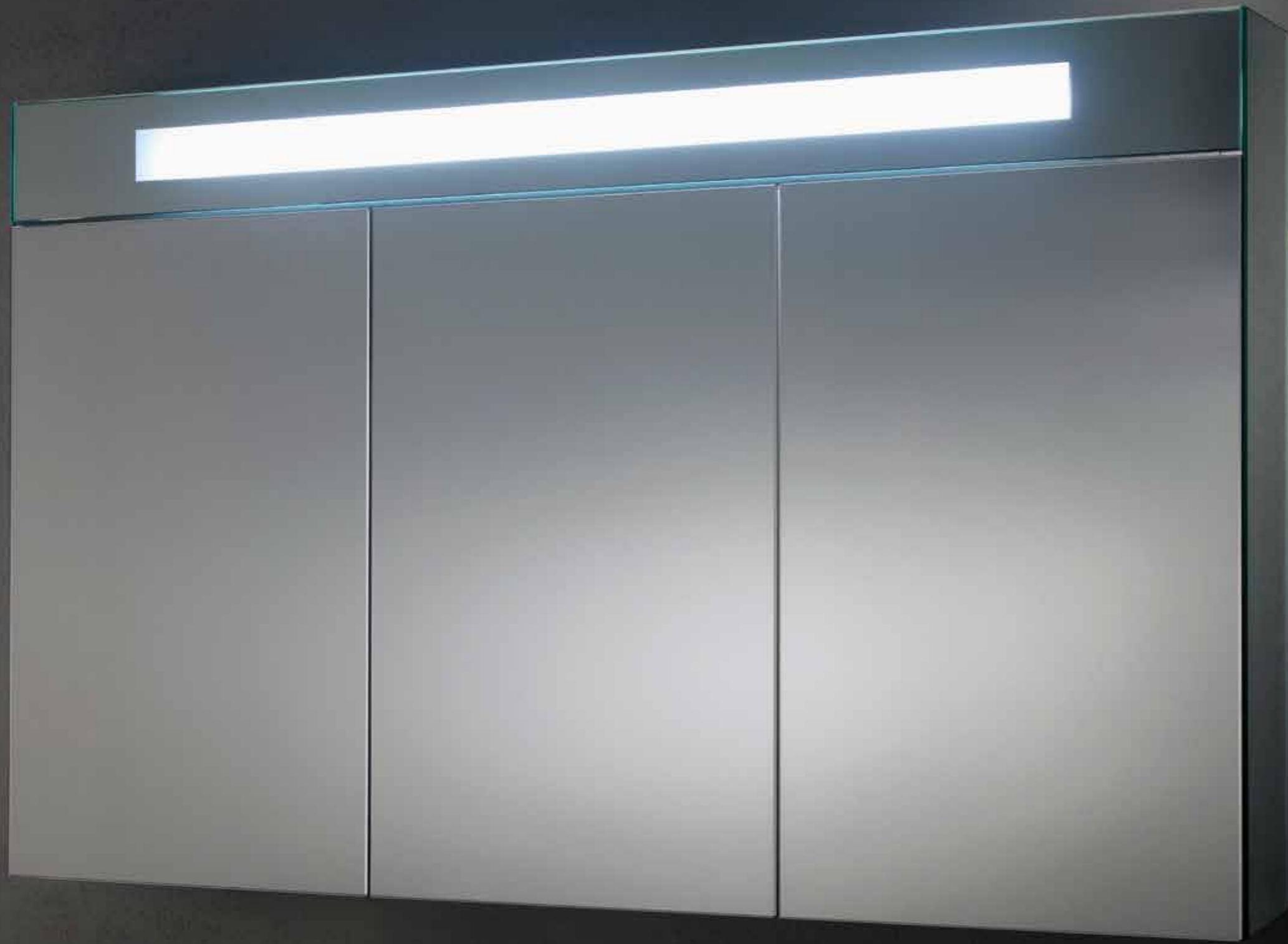

BOMBO CON ILLUMINAZIONE

Dimensioni due ante/ Two doors sizes / Maße 2-türig
700/800/900x650x150mm

Dimensioni tre ante/ Three doors sizes / Maße 3-türig
1050/1150x650x150mm

Zona dedicata/ Zone / Zone

2 - 3

Consumo Energetico/ Energy Class

A++

Classe di protezione/ Protection Class

IP44



Accessori/ accessories / accessoires / Zubehör

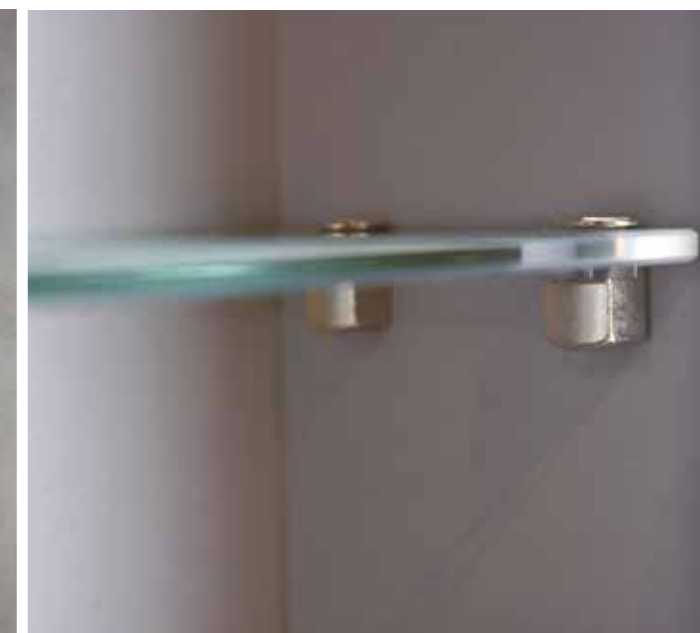
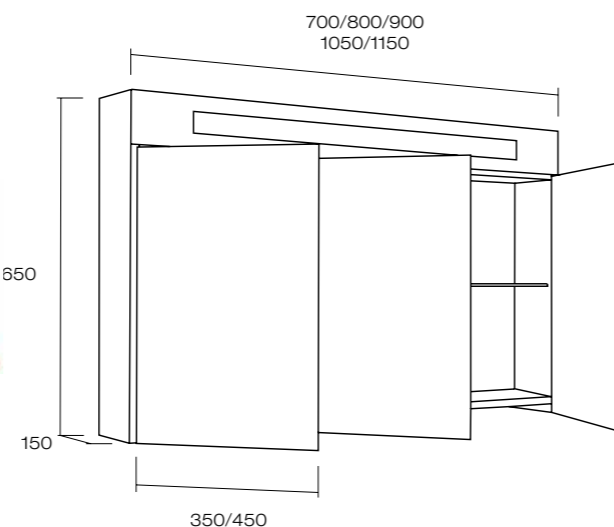

Struttura: MFC grigio o bianco mm.16 classe E1 W100

Fianchi: Specchio mm.3 Mirox 3G, incollaggio con polimero sigillante MS

Anta: Specchio+Specchio (mm.3+3) Specchio Mirox 3G, incollaggio con polimero sigillante MS

Sicurezza Specchio: Pellicola di sicurezza interna antischeggia e antisfondamento

Cerniere: 125° con frenata integrata, innesto rapido e regolazione tridirezionale

Attaccaglie: a pressione in acciaio regolazione bidirezionale con cover portata 130 kg/ coppia

Ripiano: in vetro mm.6 con ferramenta in acciaio inox autobloccante

Illuminazione: neon T15 13W IP44 consumo 13W
Alimentazione: IP44 in rete 220/250 Volts con 1 metro di cavo bipolare



Frame: gray or white MFC mm.16 E1 W100

Hips: Mirror mm.3 Mirox 3G, gluing with MS polymer sealant

Door: Mirror + Mirror (mm.3+3) mirror Mirox 3G, bonding with MS polymer sealant Mirror

Safety Mirror: Rear Safety film anti-splinter and anti-breaching

Hinges: 125° with integrated braking, quick coupling and three-way adjustment

Hangers: pressured steel hangers with bidirectional adjustment and cover, load bearing capacity 130kg/pair

Shelf: in 6 mm glass with self-locking stainless steel hardware
Lighting: neon T15 13W IP44 13W consumption
Power supply: IP44 in 220/250 Volts network with 1 meters bipolar cable



Structure: MFC gris ou blanc mm.16 classe E1 W100

Cotés: MFC mm.3 structurel gris ou blanc
Porte: Miroir+ Miroir (mm.3+3) Mirox 3G, collage par polymère MS

Sécurité Miroir: Pellicule interne de sécurité anti-éclats et anti-brise

Charnières: 125° avec Soft-Close intégré et réglage en trois directions

Fixation: à pression, en acier avec réglage bidirectionnel, portée 130 kg/ paire

Etagère: en verre mm.6 ferrure de fixation autobloquantes en acier inoxydable

Eclairage: neon T15 13W IP44 consommation 13W
Alimentation: IP44 en réseau 220/250 Volts avec 1 mètre câble bipolaire



Korpus: grau oder weiß in MFC 16 mm Kategorie E1 W100

Seiten: Spiegel 3 mm Mirox 3G, feuchtigkeitsresistente Verleimung mit MS-Polymerkleber

Türe: Spiegel + Spiegel (3 +3 mm) Mirox Spiegel 3G, Verleimung durch abdichtenden MS-Polymerkleber

Spiegelschutz: interne Sicherheitsfolie zur Verhinderung von Splitterung und Bruch

Scharniere: 125° mit integrierter Dämpfung, Schnellmontage und dreidimensionaler Einstellung

Aufhängebeschläge: Druckguss, aus Stahl zur bidirektionalen Regulierung mit Abdeckkappen, Belastbarkeit 130 kg/ pro Paar

Einlegeboden: aus Glas 6 mm mit selbstsperrenden rostfreien Stahlschrauben
Beleuchtungssystem: Stromversorgung:



Accessori specchi
Mirror accessories
 Accessoires miroirs
 Spiegelzubehör

 **Accensione touch**
 Touch switch
 Interrupteur Touch
 Antipp-Einschaltung

 **Luce esterna**
 Exterior light
 Éclairage extérieur
 Au enbeleuchtung

 **Grado di protezione IP44**
 Protection class IP44
 Indice de Protection IP44
 Schutzklasse IP44

 **Luce interna**
 Interior light
 Éclairage intérieur
 Innenbeleuchtung

 **Specchio**
 Mirror
 Miroir
 Spiegel

 **Antiappannamento**
 Demister
 Anti-buée
 Antibeschlag

 **Luce di cortesia**
 Courtesy Light
 Éclairage de courtoisie
 Orientierungslicht

 **Preso IP44**
 Socket IP44
 Prise IP44
 Steckdose IP44

 **Ingranditore 2x**
 Cosmetic mirror 2x
 Agrandisseur 2x
 Vergrößerungsspiegel 2x

 **Luce accessorio esterno**
 External accessory light
 Éclairage accessoire extérieure
 Zusätzliches Au enlicht

 **Porta phon**
 Hairdryer holder
 Porte Sèche-Cheveux
 Fönhalterung

 **Dimmerabilità**
 Dimmable
 Dimmable
 Dimmer

 **Classe di isolamento 2**
 Isolation class 2
 Classe d'isolation 2
 Isolierklasse 2

 **Porta salviette**
 Wipes Holder
 Porte Kleenex
 Ablage für Kosmetiktücher

 **Fragile**
 Handle with care
 Fragile
 Zerbrechlich

 **Accensione IR**
 IR switch
 Interrupteur IR
 Schalter IR

Zone
 Zone
 Zone
 Zone

Consumo energetico
 Energy consumption
 Consommation énergétique
 Energieverbrauch

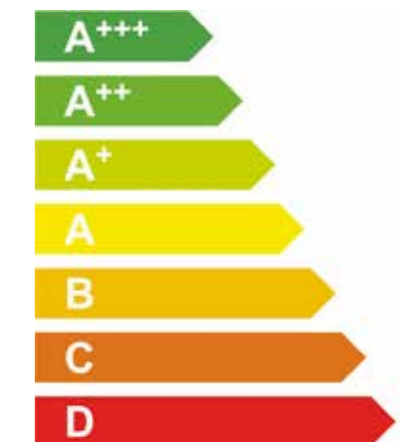

Caratteristiche degli alimentatori
 Characteristics of power supplies
 Caractéristiques des alimentations
 Eigenschaften der Stromversorger

