

LEVATOIO



LEVATOIO

Dimensioni / Sizes / Maße

700/900/1200x650x165mm

Zona dedicata/ Zone / Zone

2 - 3

Consumo Energetico/ Energy Class / Energieklasse

A++

Classe di protezione/ Protection Class / Schutzklasse

IP44

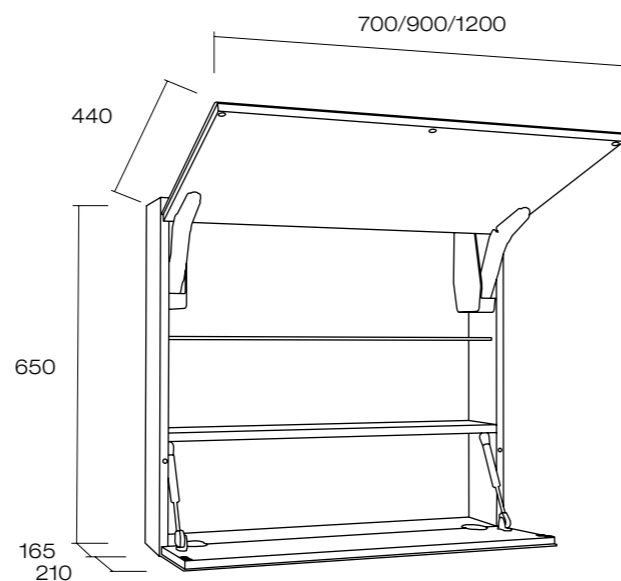

Accessori/ accessories / accessoires / Zubehör



Struttura: MFC grigio o bianco mm.16 classe E1 W100

Fianchi: Specchio mm.3 Mirox 3G, incollaggio con polimero sigillante MS

Anta: Specchio+Supporto (mm.3+12) grigio o bianco mm.12, Specchio Mirox 3G, incollaggio con polimero sigillante MS
Sicurezza Specchio: Pellicola di sicurezza posteriore antischeggia e antisfondamento
Cerniere: 107° FreeFlap cover grigia con ammortizzatore integrato e regolazione tridirezionale per l'anta e pistoncini a gas hydraulic spring per la mensola

Attaccaglie: a pressione in acciaio regolazione bidirezionale con cover portata 130 kg/ coppia

Ripiano: in vetro mm.6 con ferramenta in acciaio inox autobloccante

Illuminazione: nella versione con illuminazione 60 led/ml 4200°K IP44 consumo 4,8 W/ml

Alimentazione: SELV, MM, F, IP44 12 Volts con 1 metro di cavo bipolare



Frame: gray or white MFC mm.16 E1 W100

Hips: Mirror mm.3 Mirox 3G, gluing with MS polymer sealant

Door: Mirror + Support (mm.3+12) MFC gray or white mm.12, mirror Mirox 3G, bonding with MS polymer sealant

Safety Mirror: Rear Safety film anti-splinter and anti-breaching

Hinges: 107° FreeFlap gray cover with integrated damper and adjustment tridirectional for leaf and-piston hydraulic gas spring for the shelf

Hangers: pressured steel hangers with bidirectional adjustment and cover, load bearing capacity 130kg/pair
Shelf: in 6 mm glass with self-locking mounting brackets

Lighting: in the version with lighting 60 led/ml 4200°K IP44 consumption 4.8 W / ml

Power supply: SELV, MM, F, IP44 12 Volts with 1 meters bipolar cable



Structure: MFC gris ou blanc mm.16 classe E1 W100

Cotés: Miroir mm.3 Mirox 3G collage par polymère MS
Porte: Miroir + Support (mm.3+12) Miroir Mirox 3G, collage avec polymère MS

Sécurité Miroir: Pellicule arrière de sécurité anti-éclats et anti-brise
Charnières: 107° FreeFlap avec bouchon gris à réglage en trois directions pour la porte et pistons hydrauliques pour l'étagère

Fixation: à pression, en acier avec réglage bidirectionnel, portée 130 kg/ paire

Etagère: en verre mm.6 ferrure de fixation autobloquantes en acier inoxydable

Eclairage: dans la version avec éclairage 60 led/ml 4200°K IP44 consommation 4,8 W/ml

Alimentation: SELV, MM, F, IP44 12 Volts avec 1 mètre de câble bipolaire



Korpus: grau oder weiß in MFC 16 mm Kategorie E1 W100

Seiten: Spiegel 3 mm Mirox 3G, feuchtigkeitsresistente Verleimung mit MS-Polymerkleber

Türe: Spiegel + Platte (3 + 12 mm) in MFC grau oder weiß 12 mm, Mirox Spiegel 3G, Verleimung durch abdichtenden MS-Polymerkleber

Spiegelschutz: Sicherheitsfolie auf der Rückseite zur Verhinderung von Splitterung und Bruch

Scharniere: 107° Hochklappbeschläge FreeFlap mit grauer Abdeckkappe, eingebautem Dämpfmechanismus und dreidimensionaler Einstellung für die Türe und Klapptürbeschläge mit Gasfedern für die Klappe

Aufhängebeschläge: Druckguss, aus Stahl zur bidirektionalen Regulierung mit Abdeckkappen, Belastbarkeit 130 kg/ pro Paar

Einlegeboden: aus Glas 6 mm mit selbstsperrenden rostfreien Stahlschrauben

Beleuchtungssystem: bei der Variante mit Beleuchtung 60 Led/ml 4200°K IP44 Verbrauch 4,8 W/ml

Stromversorgung: SELV, MM, F, IP44 12/24 Volt mit einem Meter bipolarem Kabel

Accessori specchi
Mirror accessories
 Accessoires miroirs
 Spiegelzubehör

 **Accensione touch**
 Touch switch
 Interrupteur Touch
 Antipp-Einschaltung

 **Luce esterna**
 Exterior light
 Éclairage extérieur
 Au enbeleuchtung

 **Grado di protezione IP44**
 Protection class IP44
 Indice de Protection IP44
 Schutzklasse IP44

 **Luce interna**
 Interior light
 Éclairage intérieur
 Innenbeleuchtung

 **Specchio**
 Mirror
 Miroir
 Spiegel

 **Antiappannamento**
 Demister
 Anti-buée
 Antibeschlag

 **Luce di cortesia**
 Courtesy Light
 Éclairage de courtoisie
 Orientierungslicht

 **Presa IP44**
 Socket IP44
 Prise IP44
 Steckdose IP44

 **Ingranditore 2x**
 Cosmetic mirror 2x
 Agrandisseur 2x
 Vergrößerungsspiegel 2x

 **Luce accessorio esterno**
 External accessory light
 Éclairage accessoire extérieure
 Zusätzliches Au enlicht

 **Porta phon**
 Hairdryer holder
 Porte Sèche-Cheveux
 Fönhalterung

 **Dimmerabilità**
 Dimmable
 Dimmable
 Dimmer

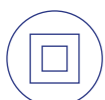
 **Classe di isolamento 2**
 Isolation class 2
 Classe d'isolation 2
 Isolierklasse 2

 **Porta salviette**
 Wipes Holder
 Porte Kleenex
 Ablage für Kosmetiktücher

 **Fragile**
 Handle with care
 Fragile
 Zerbrechlich

 **Accensione IR**
 IR switch
 Interrupteur IR
 Schalter IR

Zone
 Zone
 Zone
 Zone

Consumo energetico
 Energy consumption
 Consommation énergétique
 Energieverbrauch

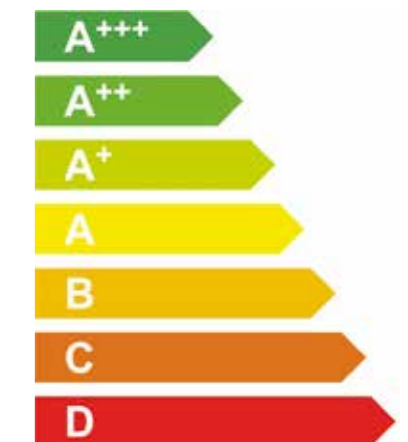

Caratteristiche degli alimentatori
 Characteristics of power supplies
 Caractéristiques des alimentations
 Eigenschaften der Stromversorger

